

# Graphic VFD Module

# GU84x16D-K610A1

- 84 x 16 Dot Matrix
- Single 5V Supply
- High Brightness Display
- Wide Temperature +105°C
- SPI interface + /Reset

This compact high brightness VF display module provides a solution for ovens and control systems. The unique low profile onboard DC/DC convertor avoids using inductive components or electrolytic capacitors to enable a wide temperature range.

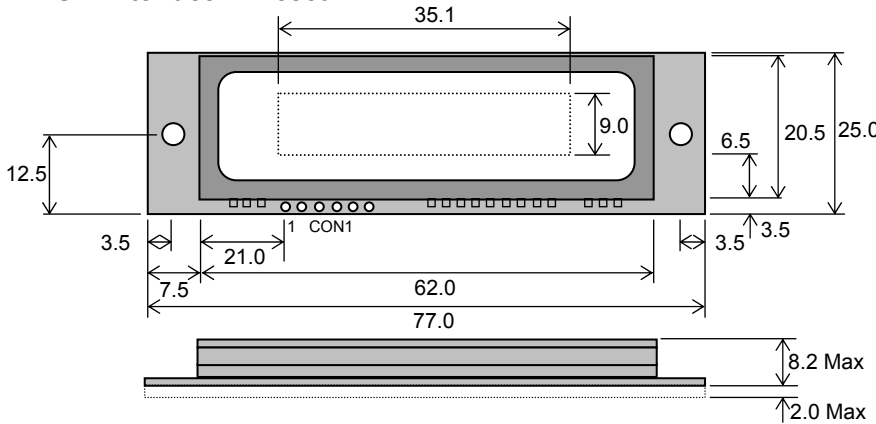

CON1	
Pin	Signal
1	VCC
2	GND
3	Clock
4	Data OUT
5	Data IN
6	/RESET

Dimensions in mm.  
Tolerances +/-0.1mm.  
PCB is 1.6mm thick

## ELECTRICAL SPECIFICATION

Parameter	Sym	Min	Typ	Max	Unit	Condition
Supply Voltage	Vcc	4.5	5.0	5.5	V	Vss=0V
Supply Current	Icc	-	200	250	mA	Vcc=5V All dots
Logic High Input	V <sub>IH</sub>	3.7	-	Vcc	V	Vss=0V
Logic Low Input	V <sub>IL</sub>	0	-	0.3	V	Vss=0V

## ENVIRONMENTAL and OPTICAL SPECIFICATION

Parameter	Value
Display Area (XxY mm)	35.1 x 9.0
Dot Size/Pitch (XxY mm)	0.27 x 0.42/0.42 x 0.57
Luminance	2000 cd/m <sup>2</sup> Typ
Colour of Illumination	Blue-Green (Filter for colours)
Operating Temperature	-40°C to +105°C - 4 hour peak
Storage Temperature	-40°C to +85°C - continuous
Operating Humidity (non condensing)	10 to 90% @ 25°C

## SOFTWARE COMMANDS

Hex	Command
00-07	Display user defined 8x8 icon in EEPROM at cursor
08-0D	Display user defined 16x16 icon in EEPROM at cursor
10+	Position Cursor where top left = 0,0 (10, x, y)
11	Set Pixel On at Cursor
12	Clear Pixel at Cursor
13+	Fill Area, co-ordinates inclusive (13, tx, ty, bx, by)
14+	Clear Area, co-ordinates inclusive (14, tx, ty, bx, by)
15+	Invert Area, co-ordinates inclusive (15, tx, ty, bx, by)
16+	Draw boxed outline, co-ordinates inclusive (16, tx, ty, bx, by)
17+	Clear boxed outline, co-ordinates inclusive (17, tx, ty, bx, by)
18+	Set write mode (18, mode)
19+	Define icon (19, 00-07, n1, ... n8) or (19, 08-0D, n1, ... n32)
1A+	Graphic write (1A, n1, ... n168)
1C+	Set luminance (1C, 00-1F)
1D	Select 5x7 Font
1E	Select 10x14 Font
1F	Software reset
20-7F	Write ASCII Characters (5x7 font)
20-5F	Write ASCII Characters (10x14 font)

The module defaults to a 2 x 14 character display using the 5x7 font with single pixel spacing. The cursor position auto increments after each character write. The bottom left of a character is placed at the cursor x,y. 8 bit data is sent via synchronous SPI on the falling edge of clock.

## 5X7 FONT

	00	01	02	03	04	05	06	07	08	09	0A	0B	0C	0D	0E	0F
00																
10																
20	!	"	#	\$	%	&	'	(	)	*	+	,	-	.	/	
30	0	1	2	3	4	5	6	7	8	9	:	;	<	=	>	?
40	@	A	B	C	D	E	F	G	H	I	J	K	L	M	N	O
50	P	Q	R	S	T	U	V	W	X	Y	Z	[	\	]	^	_
60	`	a	b	c	d	e	f	g	h	i	j	k	l	m	n	o
70	p	q	r	s	t	u	v	w	x	y	z	{	}	~		

## 10X14 FONT

	00	01	02	03	04	05	06	07	08	09	0A	0B	0C	0D	0E	0F
00																
10																
20	!	"	#	\$	%	&	'	(	)	*	+	,	-	.	/	
30	0	1	2	3	4	5	6	7	8	9	:	;	<	=	>	?
40	@	A	B	C	D	E	F	G	H	I	J	K	L	M	N	O
50	P	Q	R	S	T	U	V	W	X	Y	Z	[	\	]	^	_

## CONTACT

**Noritake Sales Office Tel Nos**  
 Nagoya Japan: +81 (0)52-561-9867  
 Canada: +1-416-291-2946  
 Chicago USA: +1-847-439-9020  
 Munchen (D): +49 (0)89-3214-290  
 Itron UK: +44 (0)1493 601144  
 Rest Europe: +49 (0)61-0520-9220  
[www.noritake-itron.com](http://www.noritake-itron.com)

The software command codes shown are copyright 2009 Noritake Co. Ltd

Subject to change without notice.  
 Doc Ref: 43847 Iss1 26 Jan 09

## SOFTWARE COMMANDS

Instruction	Hex	Description
Display 8x8 Icon (BUSY = 300us)	00H - 07H	Display one of the 8 available 8x8 user icons at current cursor position. The cursor is shifted 8 pixels on each icon write. Icons can be defined using the 'Define icon' command.
Display 16x16 Icon (BUSY = 400us)	08H - 0DH	Display one of the 6 available 16x16 user icons at current cursor position. The cursor is shifted 16 pixels on each icon write. Icons can be defined using the 'Define icon' command.
Cursor Positioning (BUSY = 10us)	10H + x + y	Set cursor position. X = 0 to 83, Y = 0 to 15. The cursor can be positioned off-screen in the vertical direction. The cursor position is automatically advanced on each character write. A cursor position of 0,0 defines the top left-hand corner of the display.
Pixel On (BUSY = 15us)	11H	Turn on single pixel at the current cursor position.
Pixel Off (BUSY = 15us)	12H	Turn off single pixel at the current cursor position.
Area Fill (BUSY = 10us & 300us [last byte])	13H + x1 + y1 + x2 + y2	Turn on all pixels within co-ordinates x1, y1 to x2, y2. The first co-ordinates x1, y1 should point to the top-left of the area, and x2, y2 should point to the bottom-right.
Area Clear (BUSY = 10us & 300us [last byte])	14H + x1 + y1 + x2 + y2	Turn off all pixels within co-ordinates x1, y1 to x2, y2. The first co-ordinates x1, y1 should point to the top-left of the area, and x2, y2 should point to the bottom-right.
Area Invert (BUSY = 10us & 300us [last byte])	15H + x1 + y1 + x2 + y2	Invert all pixels within co-ordinates x1, y1 to x2, y2. The first co-ordinates x1, y1 should point to the top-left of the area, and x2, y2 should point to the bottom-right.
Draw Outline (BUSY = 10us & 300us [last byte])	16H + x1 + y1 + x2 + y2	Draw single pixel width box outline from x1, y1 to x2, y2. The first co-ordinates x1, y1 should point to the top-left of the area, and x2, y2 should point to the bottom-right.
Clear Outline (BUSY = 10us & 300us [last byte])	17H + x1 + y1 + x2 + y2	Clear single pixel width box outline from x1, y1 to x2, y2. The first co-ordinates x1, y1 should point to the top-left of the area, and x2, y2 should point to the bottom-right.
Set Write Mode (BUSY = 10us)	18H + mode	Sets the writing mode used for all subsequent character and graphic writes. 00H = Overwrite existing display data (default) 01H = AND with existing display data 02H = OR with existing display data 03H = Exclusive OR with existing display data
Define Icon (BUSY = 10us & 4ms [data bytes])	19H + icon + data	Store user defined icon (00H-0DH) in non-volatile EEPROM. Icons are either 8x8 or 16x16 pixel format. The icon data should consist of 8 (for 8x8) or 32 (for 16x16) vertical bytes with the MSB uppermost. Icons 00H – 07H are 8x8 format and icons 08H – 0DH are 16x16. <i>e.g. 19H+05H+FFH+81H+81H+81H+81H+81H+81H+81H+81H+FFH - defines a box at user defined character 05H. 05H - display box character</i>
Graphic Write (BUSY = 50us)	1AH + data	Receive and display a complete screen of graphic data. Data is formatted vertically with MSB uppermost. All 168 bytes of data must be sent.
Set Luminance (BUSY = 50us)	1CH + lum	Set the overall display brightness. 00H=off, 01H=minimum, 1FH=maximum (default).
5x7 Font (BUSY = 25us)	1DH	Select 5x7 font ( <i>default</i> ). The cursor is advanced by 6 pixels on each character write.
10x14 Font (BUSY = 25us)	1EH	Select 10x14 font. The cursor is advanced by 12 pixels on each character write.
Software Reset (BUSY = 150us)	1FH	Reset the display to it's power on condition (icon data is retained).
ASCII Write (BUSY = 150us [ 5x7 ] BUSY = 300us [ 10x14 ])	20H – 7FH (5x7) 20H – 5FH (10x14)	Text is written to the display in the selected font. The cursor is moved right on each character write, if the end of the display is reached, the cursor will move back to the left-hand side of the display.

## INTERFACING TO THE GU84x16D-K609A1

Data is clocked in on the falling edge of SCK and out on the rising edge. The most significant bit of the data byte should be sent first. Although the module does have a 16 byte receive buffer the host must provide adequate delays for the module to process data / commands. These data / command busy times are specified in the software command section. It is important to use the reset input on a regular basis to ensure synchronization of data.

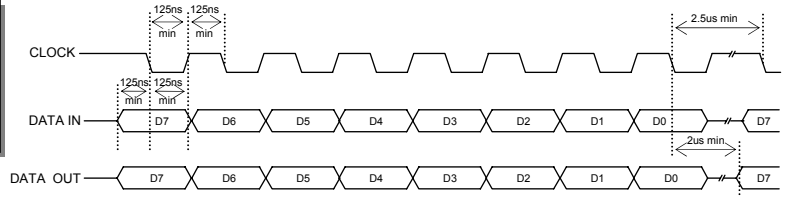
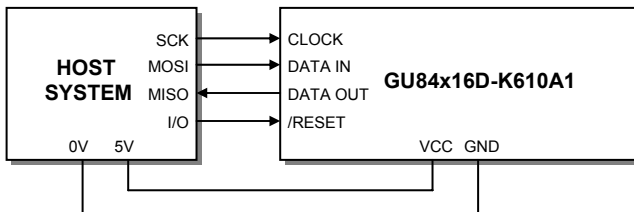

## RESET TIMING

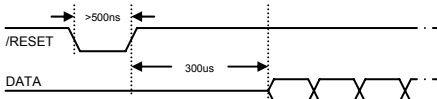

The module is reset when a low level signal is applied to the /RESET line for greater than 500ns. This will cause the module to clear the display and set all defaults. All icon data is retained. During the 300us initialisation period, the user must not send data to the module.

## DISPLAYING TEXT

The module contains a 5x7 pixel font with 96 characters and a 10x14 pixel font with 64 characters. Characters of either font size can be written to any part of the display. Characters are positioned above the current cursor position, see Fig1. Each character written will include a space to the right and below, this space size is dependant upon the selected font. The 5x7 pixel font has a one pixel space and the 10x14 font has a 2 pixel space. This space should be taken into consideration when positioning the character.

After each character is written to the display, the cursor position is automatically advanced by the width of the selected character font plus it's space. If the cursor position advances off the display, it will automatically be moved to the left side of the display (x = 0).

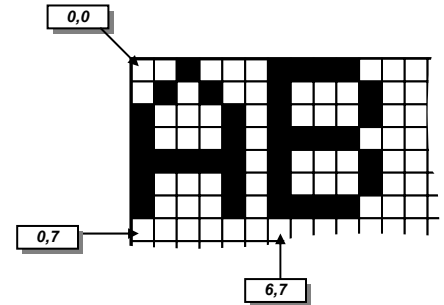
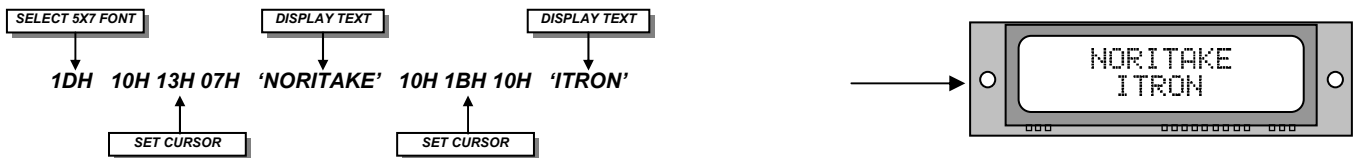

Fig1: Cursor Positioning, example of writing 2 characters from cursor position 0,7.

The following example displays two text messages in the center of the display.



## USING USER DEFINED ICONS

Eight 8x8 and six 16x16 user defined icons/characters can be stored in the VFD module's EEPROM, these are retained when the power is removed. The icon data should be in a vertical format, with the MSB uppermost. Displaying an icon is much the same procedure for displaying any standard character. An 8x8 icon is displayed by sending 00H-07H and a 16x16 icon by sending 08H-0DH.

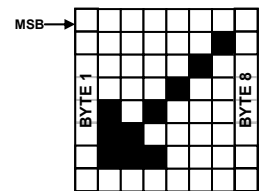
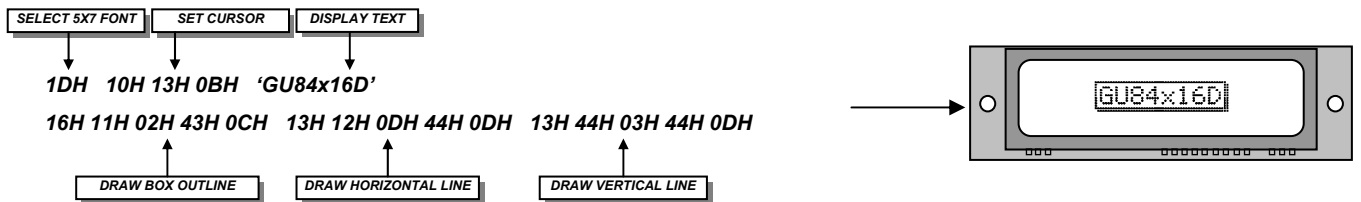

Fig3: Example Icon

## DRAWING COMMANDS

The fill, outline, set/clear pixel and invert commands allow the creation of complex displays without the need for the transferring a complete image. The following example draws a box with a drop shadow around some text.



## WRITE MODES

The default write mode is 'Overwrite'. Three other modes are selectable that define how new data merges with existing data. Use of the XOR mode can be used, for example, to flash specific text or icons. This is achieved by first setting XOR mode then simply repeatedly sending the text / icon in the same position.